

Get the edge that comes from having the perfect product



Anyone who knows about laying ceramics, laminate, parquet or carpeted floors also knows how important it is to have the right edging profiles. The versatile DURAL assortment has solutions for all needs in terms of both edge protection and of design. In addition such profiles need to be simple and thus quick to install. With DURAL profiles you can get an edge that, in terms of results and of ease of installation, has to be seen to be believed.

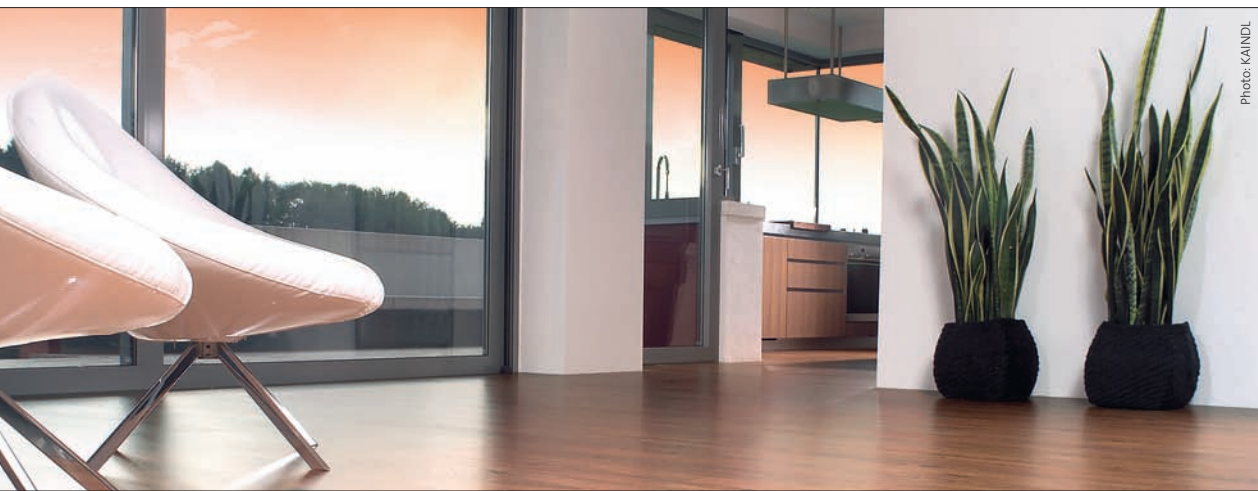

Photo: KAINDL

Key

Product category

Product name

The product is available in the materials listed here

See note below

Corner edging profiles:
DUROSOL

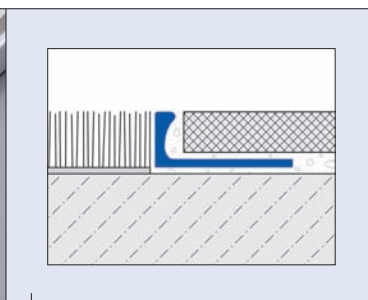

| | | | |
|-----------|-----|-----------------|-----------------|
| PVC | PVC | Brass | Brass |
| Aluminium | | Stainless steel | Stainless steel |

Universal profile for protecting the edges of tiles or for junctions between different types of flooring. Also available in bendable Z-Flex format or with wide, decorative cover

Height: 2 - 50 mm

Length: 250 cm /
Some versions also available in 100 cm fixed lengths

Product image

Graphic (cross section)

Product information

Z-Flex This logo is applied to profiles that are specially stamped to allow them to be bent into various curves.

Profiles featuring additional treatment of the visible surface are labelled with this logo.

Tile profiles



Photo: Buchthal

Square edge profiles: DUROSOL

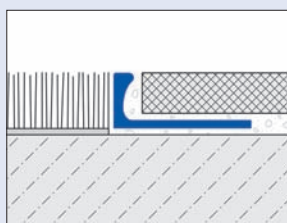

| | | | |
|-----------|--|-----------------|--|
| PVC | | Brass | |
| Aluminium | | Stainless steel | |

Universal profile for protecting the edges of tiles or for junctions between different types of flooring. Also available in bendable Z-Flex format.

Height: 2 - 50 mm

Length: 250 cm /
Some versions also available in 100 cm fixed lengths

Square edge profiles: DUROSOL 5mil

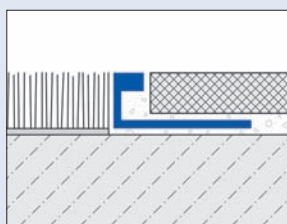

| | | | |
|--|--|-------|--|
| | | Brass | |
| | | | |

Decorative edging profile with wide visible edge. Also available in Z-Flex format.

Height: 7 - 12,5 mm

Length: 250 cm

Round edge profiles (open): DURABORD

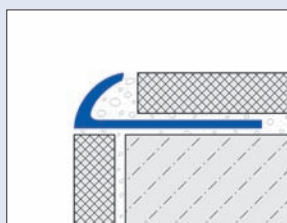

| | | | |
|-----------|--|--|--|
| PVC | | | |
| Aluminium | | | |

This 90° segment profile makes for a harmonious and aesthetically pleasing tile edging. It is particularly elegant when used for design purposes or protection at corners and corbelling in bathrooms. Available for all common tile thicknesses in a variety of colours and surface textures. Matching corners complete the range.

X-corner piece (outside corner):

Y-corner piece (outside corner):

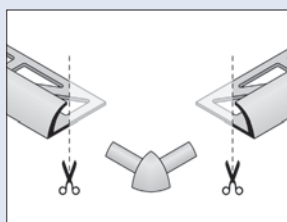
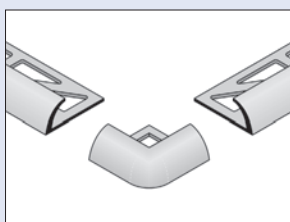

Height: 6 - 12,5 mm

Length: 250 cm /
Some versions also available in 100 cm fixed lengths

Quarter round profiles (closed): DURONDELL

Z-Flex

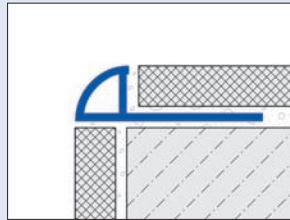

| | | | |
|-----------|--|-----------------|--|
| PVC | | Brass | |
| Aluminium | | Stainless steel | |

Robust and decorative 90°-segment profile for protection and edging of tiled surfaces. Available in a wide variety of colours and materials with matching corner pieces. Metal versions are also available as Z-Flex profiles.

X-corner piece (outside corner): Y-corner piece (outside corner): Z-corner piece (inside corner): **NEW**

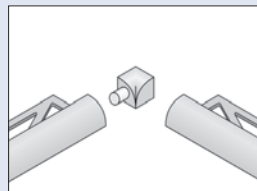
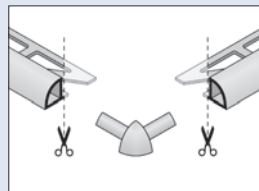
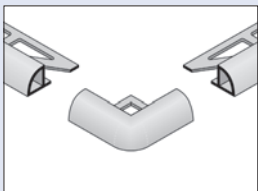

Height: 6 - 12,5 mm
Length: 250 cm

Listelli profiles: DURALIS

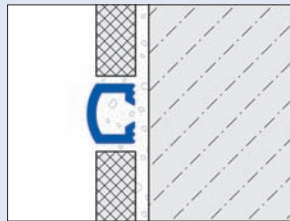

| | |
|-----------|-----------------|
| PVC | |
| Aluminium | Stainless steel |

Decorative profile for visible divides or for to provide a mix of materials in tiled floors, especially near the walls. Available in various materials and shades of colour.

Width: 10 - 40 mm **Height:** 6 - 8 mm
Length: 250 cm

Deco and separation profiles: DURAPLUS

Z-Flex

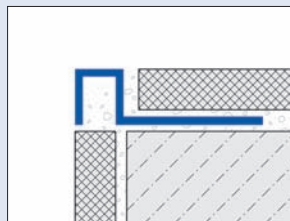
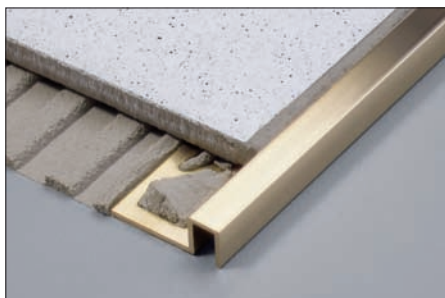

| | |
|-----------|-----------------|
| | Brass |
| Aluminium | Stainless steel |

Decorative profile with 8 mm wide visible surface. Perfect protection of edges or separation of different flooring types. A wide variety of materials, surfaces and heights make it extremely versatile.

Height: 7 - 25 mm
Length: 250 cm/
Some versions also available in 100 cm fixed lengths

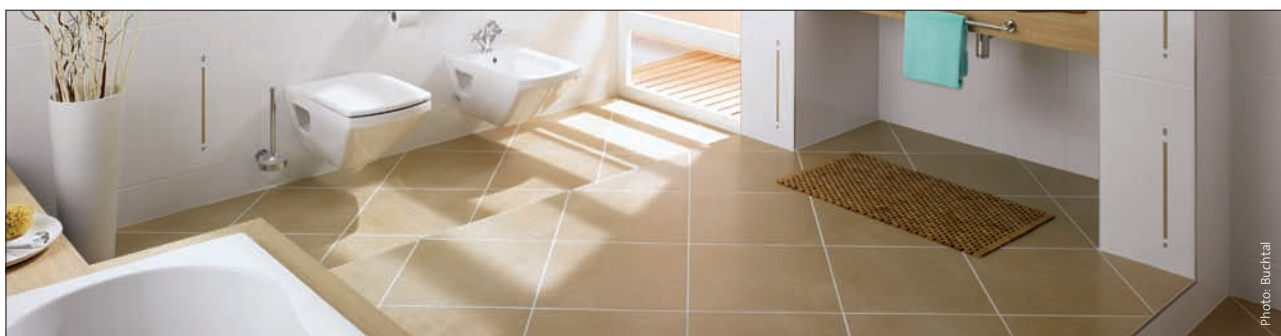
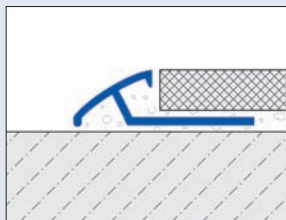

Photo: Buchthal

Tile profiles

Transition profiles to adjust different heights: DURATRANS



| | |
|-----------|-------|
| | Brass |
| Aluminium | |

Special profiles for covering junctions or edges and compensating for height differences. They eliminate ridges that might cause people to trip. The profiles are also available in Z-Flex format for bending into slight curves. They are primarily to be used in living rooms or offices.

Height: 9 - 12,5 mm
Length: 250 cm / Some versions also available in 100 cm fixed lengths

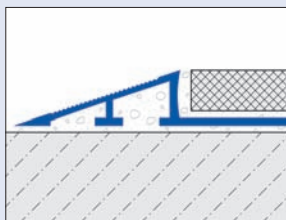

Wedge-shaped profile for junctions and edges of floors employing thicker tiles. They are used in living rooms, offices or for sales floors where wheelchairs, shopping trolleys or light transport trolleys may be used.

Height: 11 - 20 mm
Length: 250 cm / Some versions also available in 100 cm fixed lengths

Transition strip for retroactive installation: T-FLOOR

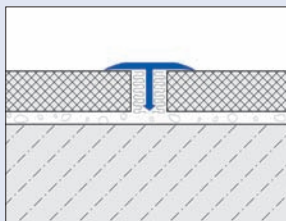

| | |
|-----------|-----------------|
| | Brass |
| Aluminium | Stainless steel |

Dividing and covering profiles for installation in junctions after laying has been completed. Two widths and various types of material are available. Can also be curved using the Z-Flex Curver.

Width: 14 - 25 mm
Length: 250 cm / Some versions also available in 100 cm fixed lengths

Divider profiles: TERRAZZO

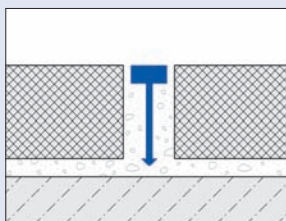

| | |
|--|-------|
| | Brass |
| | |

Decorative divider profile for use in designs with Terrazzo floors. The visible surface can be polished along with the rest of the surface

Dimensions: 5 x 3 x 10 mm, 5 x 3 x 25 mm
Length: 250 cm

STAINLESS STEEL-DIVIDER PROFILE

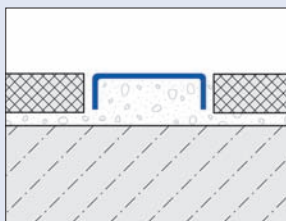

| | |
|--|-----------------|
| | Stainless steel |
| | |

Versatile stainless steel divider profile for special design applications in floor or wall coverings.

Width: 25 mm, 40 mm
Length: 250 cm

Bending profiles: Z-FLEX-PROFILES

Z-Flex



The following profiles are currently also available in the flexible, bendable Z-Flex format:

DUROSOL / DUROSOL 5mil

DURONDELL / DURAPLUS

DURATRANS / FLORENTOSTEP

T-FLOOR (can also be curved using the Z-FLEX-CURVER)

Edging profiles with Z-FLEX-stamping can be used for decorative designs in tile, laminate or parquet floors as well as with carpets. They can be curved inwards or outwards. Interesting effects can also be achieved by mixing materials.

Z-FLEX CURVER

Z-FLEX CURVER II

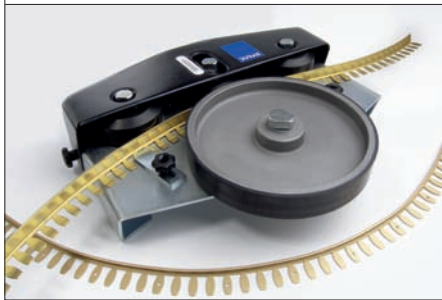

For simple and even bending of Z-FLEX profiles, special curving tools have been developed. All profiles other than the FLORENTOSTEP can be curved using the Z-FLEX CURVER.

The Z-FLEX CURVER II also allows the specially formed FLORENTOSTEP profiles to be curved. The bending disc may be gently turned using a ratchet spanner.

Step-nosing profiles: DURASTEP

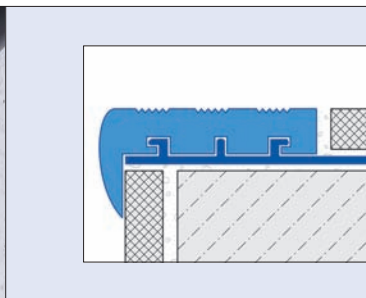

PVC (insert)

Aluminium (profile)

These two profiles (Standard / Jumbo) of differing widths, with a non-slip PVC insert in various colours, provide for the safe ascent of stairs. Jumbo-profile with five-year guarantee against wear and tear.

Width: 25 / 35 mm

Height: 7 - 13,5 mm

Length: 250 cm / Fixed length 100 cm

Wooden step-nosing profiles for indoors or outdoors: DURASTEP WOOD

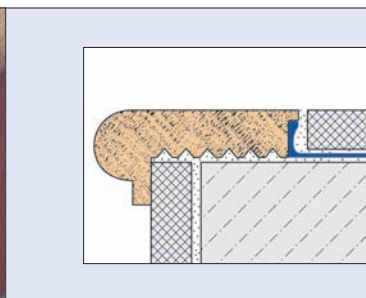

Wood (stair edge)

Aluminium (profile)

Unusual step-nosing profile featuring a hard-wood edge for Mediterranean flair. Two types of wood are available, oak for indoors and afzelia for outdoors. Profiles available in various cross sections.

Width: 50 mm

Height: 11 - 13,5 mm

Length: 250 cm / Fixed length 100 cm

Step-nosing profiles with extra-wide support base: FLORENTOSTEP

Z-Flex

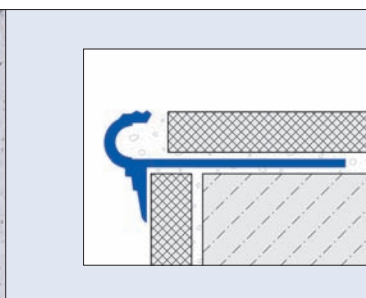

Brass

Aluminium Stainless steel

Robust step-nosing profile with extra-wide support base. Provides protection for tile edges. Ribbed for safe grip when using stairs. Available in various materials and colour shades for the most common tile thicknesses.

Height: 7 - 13,5 mm

Length: 250 cm/
Some versions also available in 100 cm fixed lengths

Tile profiles

Expansion-joint profiles: DURAFLEX

| | | | | |
|--|--|-----------|-----------------|--|
| | | PVC | | Expansion-joint profiles made of hard-soft PVC sandwich for installation using the thick-bed process. Various heights and colour shades. |
| | | | | |
| | | PVC | | Expansion-joint profiles made of hard-soft PVC sandwich for installation using the thick-bed process. With extension capability for joining lengths together. |
| | | | | |
| | | PVC | | Expansion-joint profiles made of hard-soft PVC sandwich for installation using the thin-bed process. With narrow, unperforated support base. |
| | | | | |
| | | PVC | | Expansion-joint profiles made of hard-soft PVC sandwich for installation using the thin-bed process. With wide support base containing holes. |
| | | | | |
| | | PVC | | Expansion-joint profiles made of hard-soft PVC sandwich for installation using the thin-bed process. With wide support base containing holes and an extra-narrow visible edge. One side of the base can be broken for use at junctions with walls. |
| | | | | |
| | | | Brass | Expansion-joint profiles made of DUROSOL metal profiles with an elastic insert made of EPDM. Available in various materials and profile heights. |
| | | Aluminium | Stainless steel | |
| | | Zinc | Brass | TL SERIES: Expansion-joint profiles made of hard-soft PVC sandwich for installation using the thick-bed process with anchoring. |
| | | Aluminium | Stainless steel | |





Expansion-joint profiles: DURAFLEX

| | | | |
|--|--|---|-----------------|
| | | Aluminium | |
| | | <p>SB, SC SERIES: Expansion-joint profiles for bridging wide joints in areas of heavy loading. Laid using the thick-bed process. Available for various heights and widths. SB also available as corner design. EPDM insert.</p> <p>Visible width: SB = 37 mm / SC = 45 mm Height: 15-90 mm Length: 250 cm</p> | |
| | | Aluminium | |
| | | <p>SE SERIES: Particularly robust expansion profile made entirely of aluminium for areas of heavy loading, available in various heights.</p> <p>Visible width: 70 mm Height: 43-88 mm Length: 400 cm</p> | |
| | | Aluminium | |
| | | <p>SF SERIES: Expansion-joint profiles for installation after laying of the floor with an insert made of nitrile rubber, available in two widths and corner designs.</p> <p>Visible width: 150/175 mm Length: 400 cm (Corners 90/115 mm)</p> | |
| | | | Stainless steel |
| | | <p>SG SERIES: Stainless steel expansion-joint profiles with nitrile rubber insert for areas where resistance to highly corrosive media is required, e.g. in shopping centres, warehouses and production facilities, hospitals etc.</p> <p>Visible width: 34 mm Height: 35-50 mm Length: 300 cm</p> | |
| | | Aluminium | Steel |
| | | <p>KB, KC SERIES: Expansion-joint profiles for bridging wide joints in walls. Inserts are made of highly expandable soft PVC (aluminium profile) or nitrile rubber (steel profile). Corner fittings also available.</p> <p>Visible width: 34 mm / 66 mm Height: 11-20 mm Length: 300 / 400 cm</p> | |
| | | Aluminium | Stainless steel |
| | | <p>KA SERIES: Cover profile for installation after laying of the floor that covers joints and cracks. Available in various materials and widths featuring smooth or textured surfaces. Secured by screws or self-adhesive.</p> <p>Visible width: 60-120 mm Length: 250 cm</p> | |
| | | PVC | |
| | | Aluminium | Stainless steel |
| | | <p>SERIE KE, KF: Cover profile for installation after laying of the floor, suitable for walls or floors. Secured by movable fastening clips. Available in various materials and cover widths and with corner fittings.</p> <p>Visible width: 50-140 mm Length: 300 cm</p> | |

Tile profiles

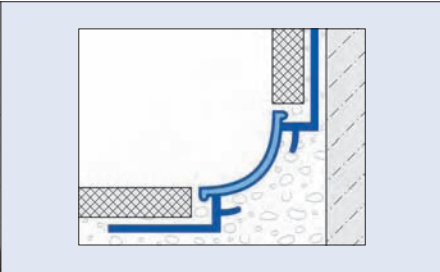
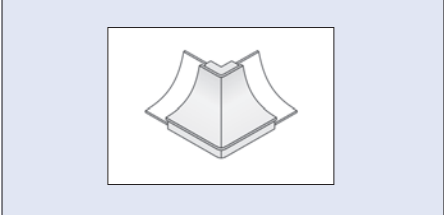
Internal coving profile for horizontal (floor/wall) and vertical (wall/wall) junctions with walls:

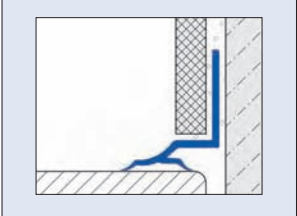
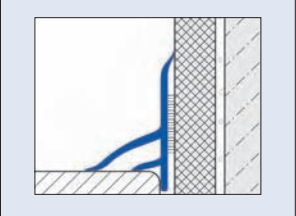
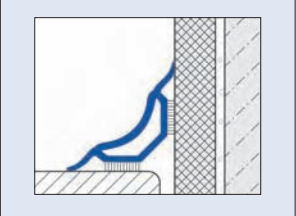
DURACOVE

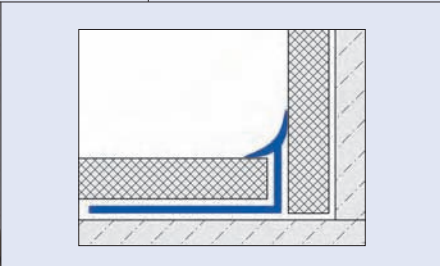
| | | | |
|---|--|---|----------------------|
|  |  | PVC | |
| <p>PVC-plastic profile of various cross section for a variety of applications involving wall junctions in bathrooms. Special profiles for junctions between bathtubs or showers and tiled walls. For sealing later on, self-adhesive bendable profiles are available on rolls. For some versions, corner pieces are also available.</p> | | | |
| Outside corner:: | Inside corner:: | | |
|  |  | | |
| Sanitary profiles, bath and shower edging profiles: | | | |
|  |  |  | |
|  |  | Height: 7 - 9 mm | Length: 183 - 250 cm |

Corner protection profiles for flush fitting with tiles:

DURAGARD

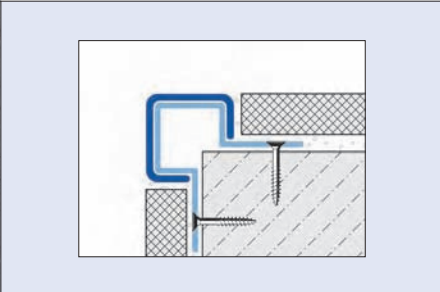
| | | | |
|---|--|--|-----------------|
|  |  | | Stainless steel |
| <p>Versatile profile system for protection of corners that can be fitted flush with tiles. Various dimensions, forms and materials are available.</p> | | | |
| <p>Edging dimensions: 25 x 25 mm to 60 x 60 mm</p> | | | |
| <p>Length: 250 cm/Some versions are available in fixed lengths of 200 cm</p> | | | |

Corner protection profiles for subsequent adhesive application:

DURAGARD

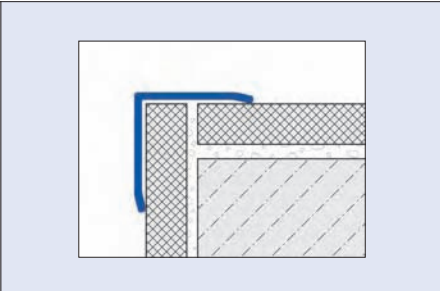
| | | | |
|--|--|-----------|-----------------|
|  |  | Aluminium | Stainless steel |
| <p>Corner profiles for protecting edges that can be glued on after laying of tiles. Various dimensions, forms and materials are available.</p> | | | |
| <p>Edging dimensions: 25 x 25 mm to 60 x 60 mm</p> | | | |
| <p>Length: 250 cm/Some versions are available in fixed lengths of 200 cm</p> | | | |